

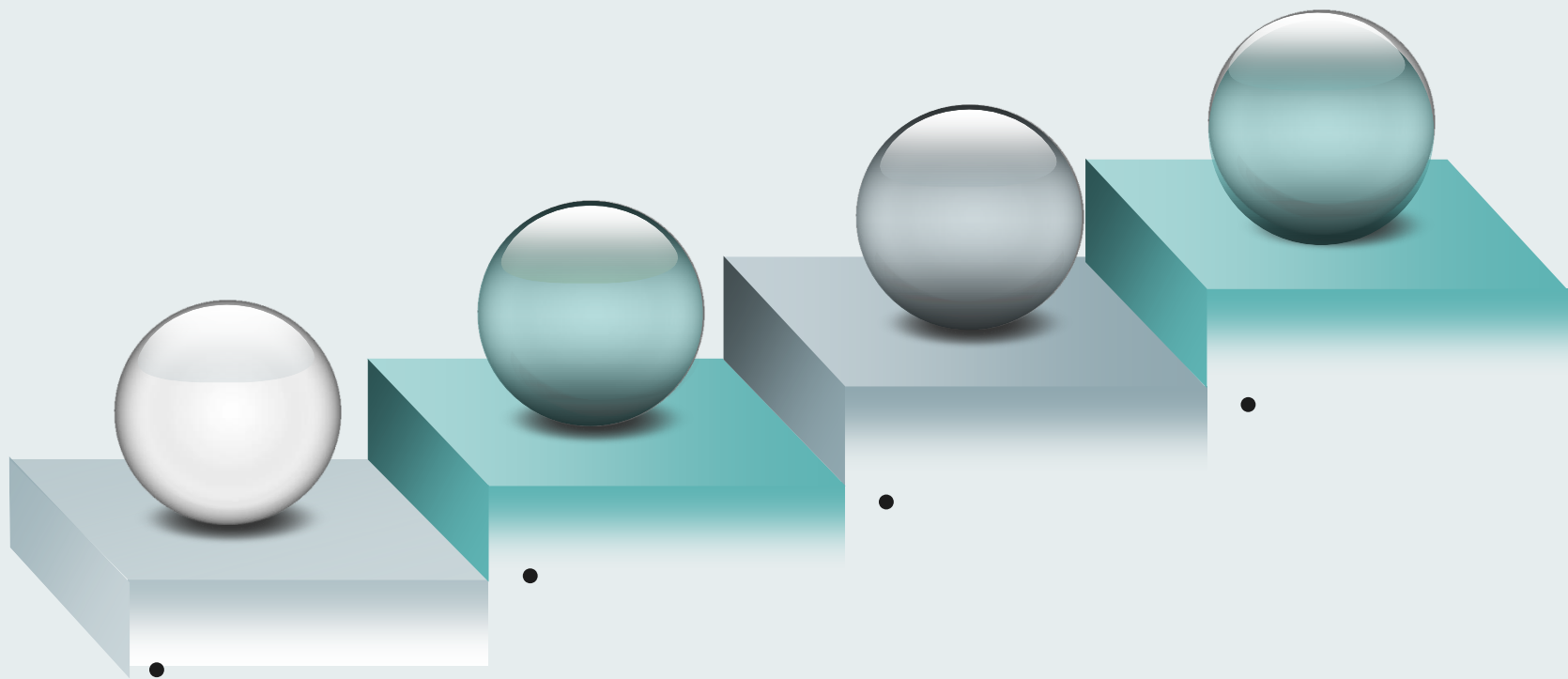

下





- 
- 
- 
- 
- 
- 

业

下

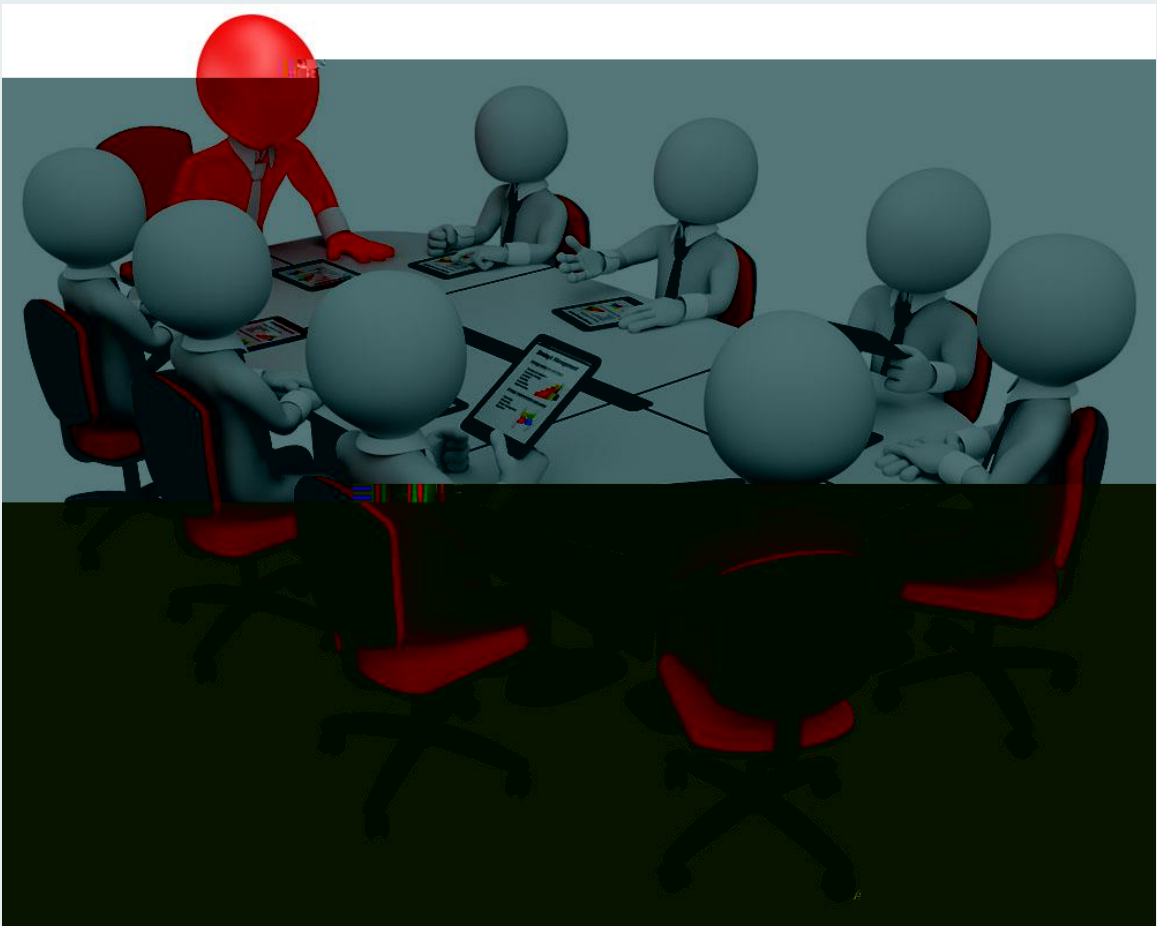

- 
- 
- 
-

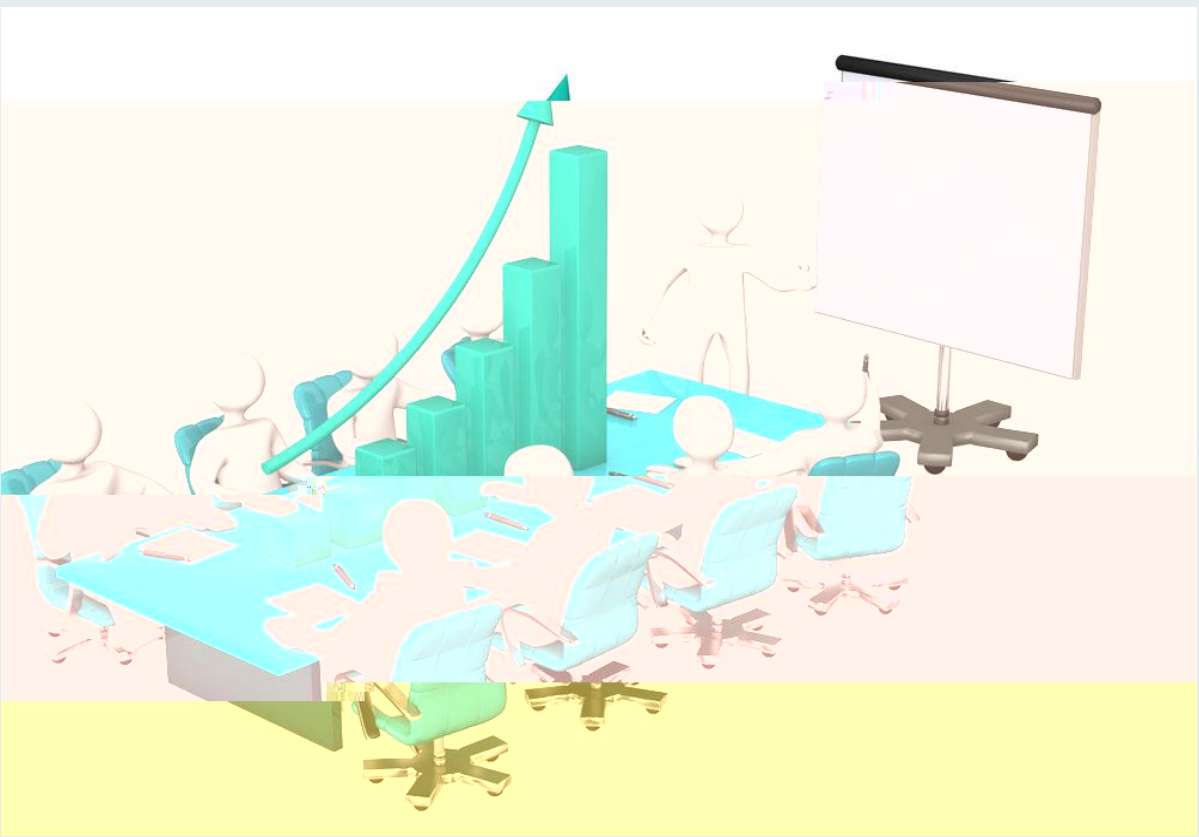

- 
- 
- 
-



- 
- 
- 
- 
- 
- 
-

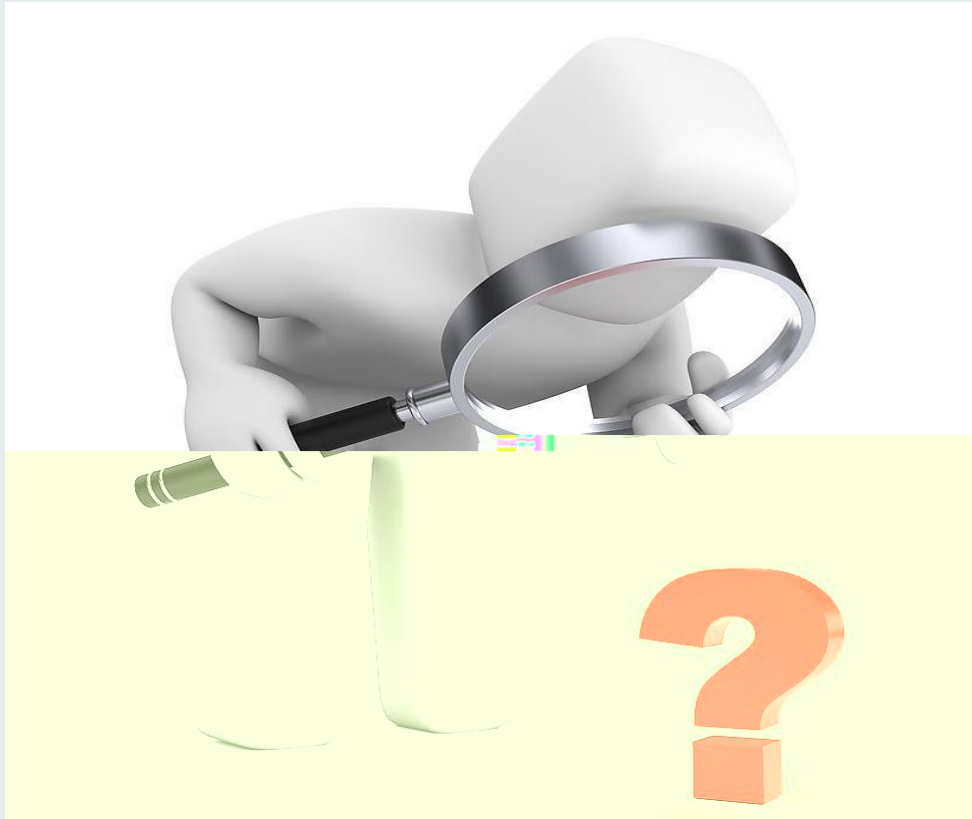

- 
- 
-

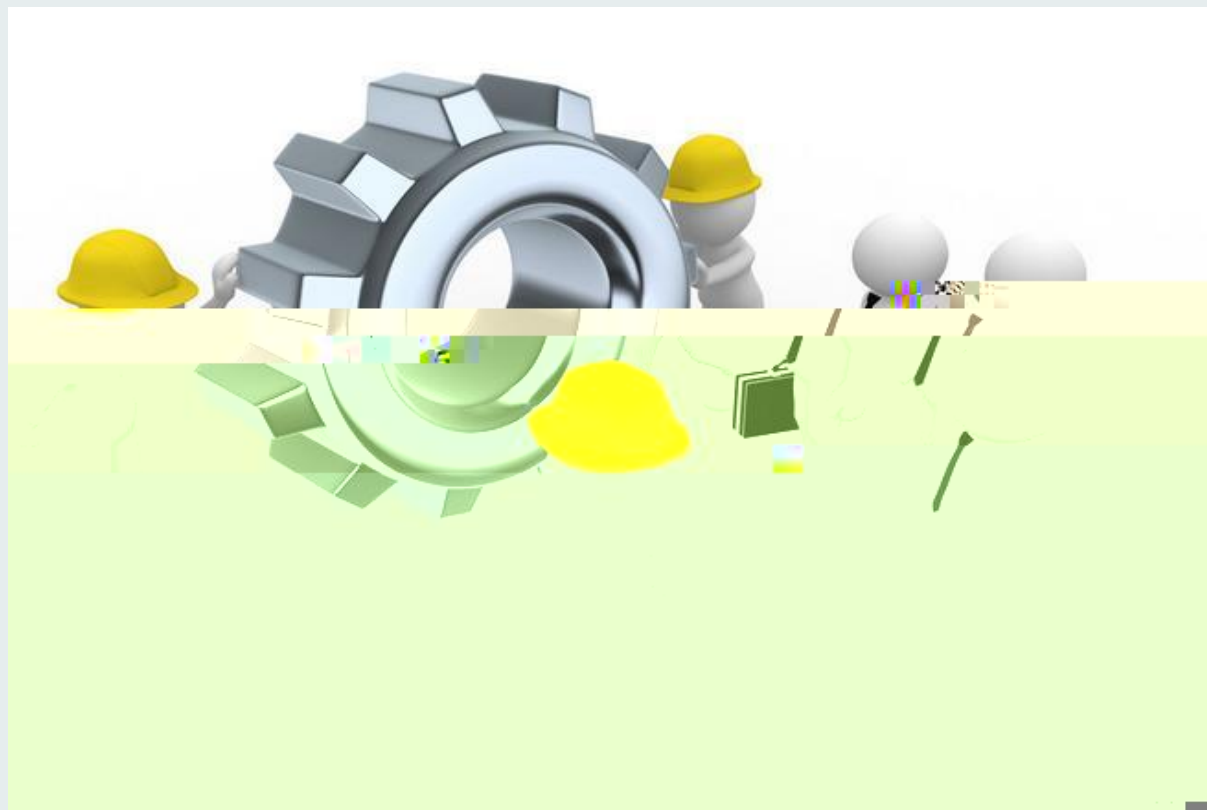





# 学

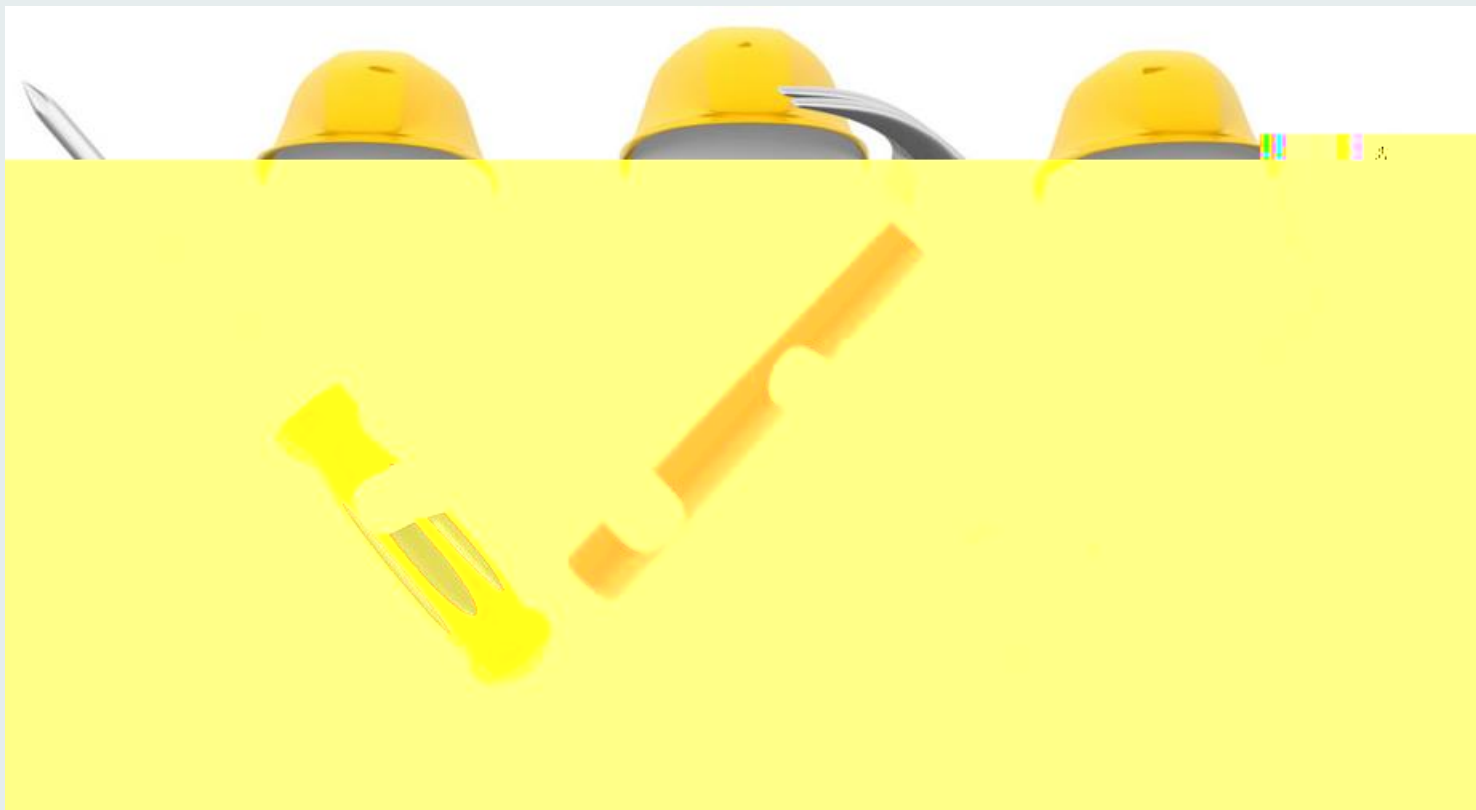

# 事

# BJNY

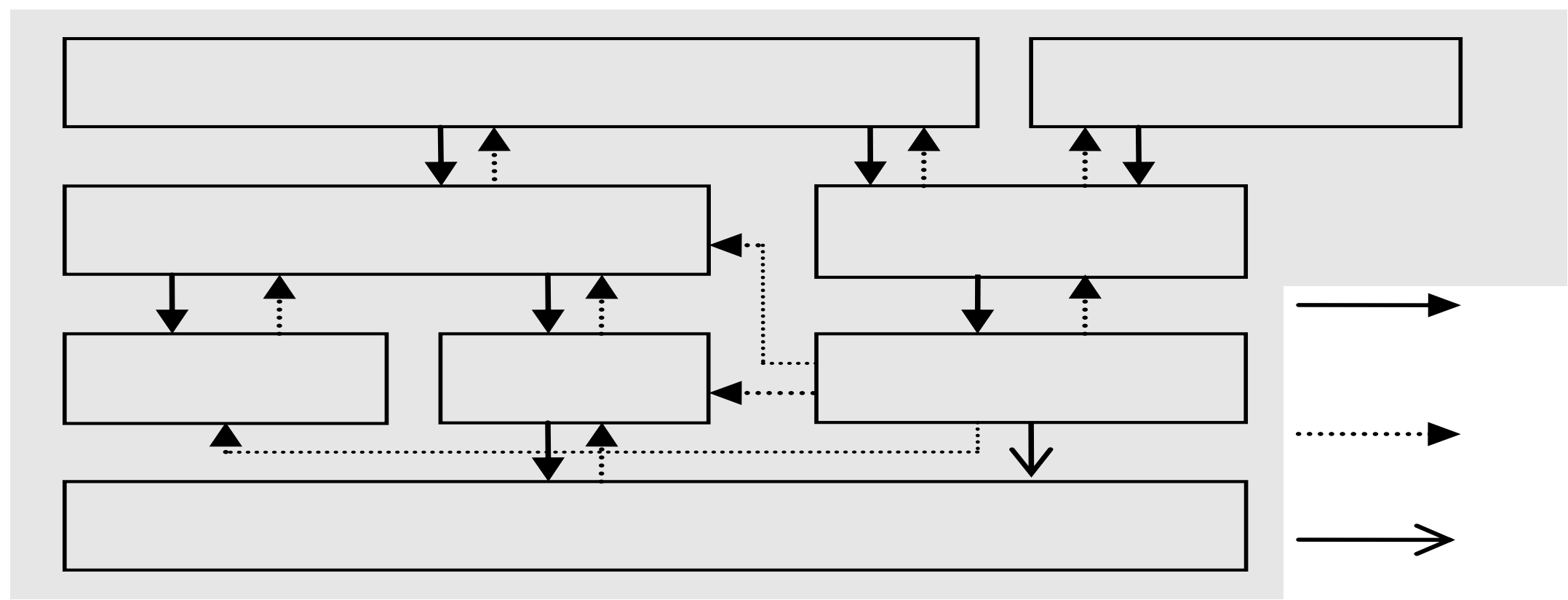

9-2 BJNY

# BJNY

- 
- 
- 
- 
- 
-

# BJNY

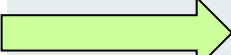
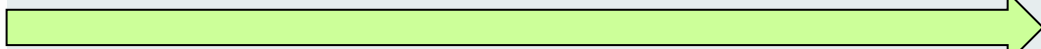
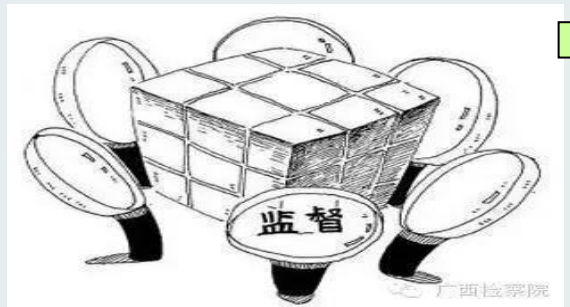

**重大风险清单** 编号: JIE/IR-2008  
NO. 06

序	活动	危险源及其风险	识别部门	风险级别	控制方式
1	行政	...	...	...	...
2	行政	...	...	...	...
3	行政	...	...	...	...
4	行政	...	...	...	...
5	行政	...	...	...	...
6	行政	...	...	...	...
7	行政	...	...	...	...
8	行政	...	...	...	...
9	行政	...	...	...	...
10	行政	...	...	...	...
11	行政	...	...	...	...
12	行政	...	...	...	...
13	行政	...	...	...	...
14	行政	...	...	...	...
15	行政	...	...	...	...
16	行政	...	...	...	...
17	行政	...	...	...	...
18	行政	...	...	...	...
19	行政	...	...	...	...
20	行政	...	...	...	...





9-3

BJNY



表 9-3

BJNY 集团“建立内部监督基础环节的主要风险及其控制措施”

业务环节	主要风险点	关键控制点	控制目标	控制措施



